



## RXP22

- Safety Precautions
- Use
- Maintenance
- Spare Parts

**RETAY**

**INDEX**

Always Keep The Muzzle Pointed In A Safe Direction.	3
Firearms Should Be Unloaded When Not Actually In Use.	3
Do Not Rely On The Firearm's Safety.	4
Be Sure Of Your Target And What Is Beyond It.	4
Use The Proper Ammunition For Your Firearm.	4
If Your Firearm Fails To Fire When The Trigger Is Pulled, Handle With Extreme Cau-tion.Firearm.	4
Always Wear Eye And Ear Protection When Shooting.	4
Be Sure The Barrel Is Clear Of Obstructions Before Shooting.	5
Do Not Alter Or Modify Your Firearm And Have It Regularly Serviced.	5
Learn The Mechanics And Handling Characteristics Of The Firearm.	5
Do Not Under Any Circumstances Operate This Firearm While Under The Influence Of Alcohol Or Drugs.	5
Warning; Lead Exposure.	6
Receive Instruction In Firearm Usage.	6
Notice	6
Safety Mechanism	7
Loading Cartridge And Operation	8
Troubleshooting	9
Unloading	10
Disassembly- Assembly	11
Sight Adjustment	12
Maintenance	12
Repairs And Customer Service	12
Limited Warranty	12
Limitation Of Liability	13
Youth Handgun Safety Act Notice	13
State-Mandated Warnings	14-15
Retay Rxp22 Cal .22lr Technical Specifications	16
Parts List	17

## RETAY RXP22



(Picture 1)

**IMPORTANT SAFETY NOTICE**

This manual contains important safety, operating, care, and maintenance instructions. To ensure safe operation of the firearm any user of this firearm must read and understand this manual before use. Failure to follow the instructions and heed the warnings in this manual may result in property damage, personal injury, and/or death. This manual should always accompany this firearm and be transferred with it upon change in ownership.

**FIREARM SAFETY RULES****1. ALWAYS KEEP THE MUZZLE POINTED IN A SAFE DIRECTION.**

**This is the most important rule of firearm safety.** A safe direction is one in which an accidental discharge will not cause injury to yourself or others. Do not point your firearm at anything you don't intend to shoot. Pay particular attention to your muzzle when loading and unloading. Treat every firearm as if it were loaded. If you keep your firearm pointed in a safe direction no one will be injured by an accidental discharge.

**2. FIREARMS SHOULD BE UNLOADED WHEN NOT ACTUALLY IN USE.**

Load your firearm only when you're in the field or on the range and ready to fire. Never allow a loaded firearm out of your sight or your hands. As soon as you are finished shooting unload your firearm; do not wait until you carry it to your car, camp, or home. "Unloaded" means there is no ammunition in the chamber or the

magazine. Keep the firearm's action open when not in use. Never assume a firearm is unloaded; always check for yourself even if you were the last person to use it. Before handling the firearm or handing to someone else visually inspect the chamber, receiver, and magazine to be certain it is unloaded. These rules should be followed even if the firearm is equipped with an internal or external security measure (e.g., cable lock, trigger guard, etc.).

Safe storage is as important as safe handling; do not store your firearms loaded. Store ammunition securely and separate from your firearms. Keep your firearms stored and secured in a safe location where unauthorized persons cannot access them without your knowledge and permission. **It is especially important to secure your firearms in such manner and location that children do not gain access to them.**

### 3. DO NOT RELY ON THE FIREARM'S SAFETY.

Treat every firearm as if it can fire at any time where or not there is pressure on the trigger. Although very unlikely, because a firearm's safety is a mechanical device it can fail. The more likely reason a firearm's safety can fail is human error. You may think the safety is on when it is not or improper handling of the firearm may result in accidentally disengaging the safety. You may not think or recognize there is ammunition in the firearm. The safety is a backup to proper firearm handling and operation; it is not a substitute for common sense and awareness on behalf of the user.

Do not touch the trigger until you are ready to shoot and keep your fingers away from the trigger when loading and unloading. Do not pull the trigger when the safety is engaged or is located in between safe and fire.

### 5. USE THE PROPER AMMUNITION FOR YOUR FIREARM.

Using a single round of improper or incorrect ammunition can destroy a firearm and cause serious personal injury. It is your responsibility to make sure the ammunition you use is a match for the caliber or gauge of your firearm and is in proper working order. Always follow instructions on ammunition boxes.

Only use ammunition loaded by an ammunition manufacturer. **Never use ammunition which is damaged, corroded, or otherwise defective, or ammunition which is dirty, wet, dented, deformed or in which the bullet has been pushed back into the cartridge case. Never use foreign military surplus ammunition, or other ammunition of questionable quality, age or origin.** Handloaded or reloaded ammunition that deviates from manufacturer specifications can be extremely dangerous and result in numerous firearm malfunctions or complete destruction of the firearm. The use of reloaded, "remanufactured" or handloaded ammunition, unjacketed lead ammunition or any ammunition which is not to the appropriate SAAMI or NATO standards, will **VOID THE WARRANTY** and may be unsafe, possibly causing damage to the firearm, serious personal injury or death.

### 4. BE SURE OF YOUR TARGET AND WHAT IS BEYOND IT.

Do not fire unless you know exactly where your shot is going and what it will strike. Be sure your bullet will not injure anyone or anything beyond your target. Do not fire at noises, movements, or patches of color. Be sure your shot has a backstop such as a hillside or dense material. Know how far your shot will travel if you miss your target or the bullet ricochets.

### 6. IF YOUR FIREARM FAILS TO FIRE WHEN THE TRIGGER IS PULLED, HANDLE WITH EXTREME CAUTION.

If the ammunition does not fire when you pull the trigger, stop and recall the first rule; always keep the muzzle pointed in a safe direction. With the muzzle pointed in a safe direction wait at least 30 seconds – to ensure the ammunition is not delayed in firing – before engaging the safety, carefully opening the action while keeping your face away from the breech, unloading the firearm, and disposing of the failing round safely. Even though the cartridge may not have fired, continue to treat your firearm as if it can discharge.

### 7. ALWAYS WEAR EYE AND EAR PROTECTION WHEN SHOOTING.

Exposure to the noise from firearm use can permanently damage hearing and flying debris, such as powder residue and ejected cartridge cases, can injure your eyes. To avoid injury, you should wear both eye protection (such as shooting glasses) and ear protection (such as sound-deafening headsets) when using your firearm. You should also wear eye protection when disassembling and cleaning your firearm to ensure that cleaning solvents and parts under tension do not come into contact with your eyes.

## 8. BE SURE THE BARREL IS CLEAR OF OBSTRUCTIONS BEFORE SHOOTING.

**Discharging a firearm with an obstruction in the barrel can result in personal injury, property damage or death.** Before you load your firearm, check the chamber and magazine to ascertain that no ammunition is inside. Also, check the inside of the bore to ensure it is free of obstructions. Even a small amount of mud, snow or excess lubricating oil or grease in the bore can cause excessive pressures resulting in a bulged or burst barrel which can injure or kill the shooter and bystanders. It is a good idea to make a habit of cleaning the bore and checking for obstructions with a cleaning rod just before each shooting session. If the noise or recoil experienced upon firing seems low or weak, or something doesn't feel "right," cease firing immediately, release the magazine, clear the firearm's chamber, engage the firearm's safety, and check to make sure that there is no obstruction in the barrel.

## 10. LEARN THE MECHANICS AND HANDLING CHARACTERISTICS OF THE FIREARM.

This manual should be read prior to usage of the firearm. Not all firearms are the same and as such the method of handling the firearms will vary with the mechanical characteristics of the firearm. Anyone who plans to use a firearm should first become completely familiar with the type of firearm and the safe handling procedures for loading, unloading, carrying, shooting, and storage.

## 9. DO NOT ALTER OR MODIFY YOUR FIREARM AND HAVE IT REGULARLY SERVICED.

Your firearm has been designed to operate according to certain factory specifications. **Modification of the mechanical components of your firearm will void your warranty.** Additionally, modification may jeopardize the safety of yourself and others.

As a mechanical device your firearm is subject to wear and must be maintained and periodically serviced to ensure optimum performance and safety. Only a qualified service provider should service, repair, or modify your firearm. Contact Retay to arrange for servicing of your firearm by Retay or one of its authorized repair centers.

Proper cleaning and lubrication are important to ensure firearm reliability, accuracy, and safety. Before cleaning always make sure the firearm is unloaded checking both the chamber and magazine. Make it a practice to clean your firearm after every use. Additionally, you should clean the barrel from the chamber end to muzzle prior to usage. If your firearm has been stored for a long time without use be sure to clean and lubricate the firearm. Cleaning is also important following exposure to conditions such as rain, dirt, mud, snow, sleet, or saltwater. Do not overlubricate your firearm.

## 11. DO NOT UNDER ANY CIRCUMSTANCES OPERATE THIS FIREARM WHILE UNDER THE INFLUENCE OF ALCOHOL OR DRUGS.

Do not handle firearms after consumption of alcohol or taking drugs that can affect your mental or physical state as you cannot handle a firearm safely while under the influence. If you are taking prescription medication seek your doctor's advice to be sure that you are able to handle and shoot a firearm safely.

## 12. WARNING; LEAD EXPOSURE.

Discharging firearms in poorly ventilated areas, cleaning firearms or handling ammunition may result in exposure to lead and other substances known to cause birth defects, reproductive harm, cancer and other serious injury. Have adequate ventilation at all times when shooting. Wash hands thoroughly after exposure.

**Most ammunition and cartridge primers contain lead, which is a toxic(poisonous) substance!** With most types of ammunition, shooting a firearm produces vapor and particles of lead, which is a toxic (poisonous) substance. Especially (but not only) in poorly ventilated range areas, breathing air which contains the lead vapor and particles is harmful to one's health, and can result in lead poisoning. Pregnant women, unborn fetuses, nursing mothers, infants and young children are especially susceptible to the risks of lead ingestion. Handling, firing and cleaning firearms, and handling ammunition, empty cartridge cases, target frames and other range equipment can deposit lead on one's hands and face, which can then be ingested (swallowed) if one drinks, eats or chews gum or tobacco products without first washing the hands and face. Lead poisoning can result in brain damage, nervous system disorders, digestive ailments, birth defects, and other serious physical effects or death. Shoot only in well ventilated areas. Minimize the period of time you remain on indoor shooting ranges, leaving when you are done firing. Do not eat, drink, chew, smoke, or engage in any other hand-to-mouth activity while shooting. Wash the hands and face thoroughly with soap and cool water as soon as you are finished shooting, and before eating or drinking. Do not collect fired brass in your hat, or put fired brass in your pockets. When you return from shooting, especially on an indoor range, change and wash your clothing. Do not allow children to handle or play with fired cases, shooting equipment, range bags, or shooting clothing. Consider using rubber gloves when cleaning firearms, to prevent lead and solvent from being absorbed into your skin. Wash thoroughly with soap and cool water after cleaning firearms. Take proper precautions if you reload ammunition or cast lead bullets. If you notice any symptoms or believe you may have been exposed to excessive amounts of lead, consult your physician.

## 13. RECEIVE INSTRUCTION IN FIREARM USAGE.

No manual can provide you with the benefits of firearms instruction by a properly qualified individual. If you are not an experienced firearms user you should obtain training in the safe and proper use of firearms by attending one of the many safety and shooting courses offered by the National Rifle Association, gun clubs and ranges, gun shops, shooting schools, or other qualified source of instruction.



### NOTICE

- 1- Owner and user must know and obey all local laws related with ownership and use of firearms.
- 2- Fire your shot with your arm tensioned straight ahead and firearm is at eye level (picture 3 )
- 3- Never fire a firearm while close to your head and your body. (picture 2 )
- 4- The manufacturer reserves the right to change and develop the firearm without any notice to consumers.
- 5- Always use high quality ammunition powerful enough to cycle the action.



(Picture 4)

## SAFETY MECHANISM



(Picture 5)



(Picture 6)

When the safety lever is in the position as shown at (picture 5) your firearm is in a safe position. To make the pistol ready to fire, turn the same lever to the "fire" position shown at (picture 6)

## LOADING CARTRIDGE AND OPERATION



**ENSURE THE SAFETY IS ACTIVATED.** Push the magazine button inward with your finger (picture 7) and remove magazine from the grip. Load the magazine with appropriate cartridges as identified by engravings on the barrel and/or slide of the firearm (Picture 8); these should match the cartridge as identified on the magazine. To reinstall the magazine push the magazine into the grip until a click sound is heard. (Picture 9);

To load a bullet into the chamber of the firearm, pull the slide to the rear and release (Picture 10-11) . **YOUR FIREARM IS NOW LOADED AND READY TO FIRE.** To fire the firearm, switch the safety to the off position and pull the trigger. You must pull the trigger each time for every shot.

Once firearm runs out of cartridges, the slide remains at the rear in a locked position indicating that no more cartridges are available to fire. When a fresh magazine is loaded, simply depress the slide lock and the firearm is ready to shoot again (Picture 12).

**IMPORTANT NOTICE: YOUR FIREARM MAY BE LOADED WITH A CARTRIDGE IN THE CHAMBER EVEN IF A MAGAZINE IS NOT INSTALLED. IF YOU ARE HANDLING THE FIREARM WITHOUT A MAGAZINE INSTALLED ALWAYS PULL BACK ON THE SLIDE TO OPEN THE CHAMBER TO DETERMINE IF A CARTRIDGE IS PRESENT.**

## TROUBLESHOOTING

Any firearm will, on occasion, malfunction. Malfunctions (or “stoppages”) can include the firearm failing to fire (with or without going “click”) when you pull the trigger, failing to extract or eject the fired cartridge case upon firing, “stovepiping” or trapping the fired case in the ejection port, failing to feed a round from the magazine or chamber the round as the firearm cycles, “double feeding” or feeding two rounds from the magazine at one time, or a “squib” (underpowered) cartridge which does not develop sufficient power to cycle the action, and may leave a bullet lodged in the barrel.

If you experience a malfunction, keep the muzzle pointed in a safe direction.

Engage the safety lever by putting it on “Safe” (White Dot Showing). Continue to hold the firearm aimed at the target and backstop for thirty (30) seconds in case you have a “hangfire” (slow or delayed ignition of the cartridge). If the round does not fire within 30 seconds, then keeping your face (and everyone else’s) away from the ejection port, your fingers off the trigger and outside the trigger guard, and the firearm pointed in a safe direction, proceed as follows:

1. Remove the magazine;
2. Pull the slide rearward to eject the chambered round, locking the slide back with the slide lock;
3. Inspect the chamber and breech area to be sure there are no cartridges or portions of cartridges remaining there. Then field strip the firearm and look through the bore from the rear to be sure it is not obstructed;
4. Segregate the faulty or damaged round of ammunition for proper disposal in accordance with the ammunition manufacturer’s instructions;
5. If the firearm is free of ammunition, fired cases, other debris or bore obstructions, you may reassemble it, reload it and continue firing.

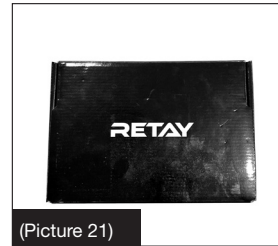
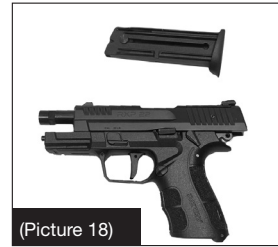
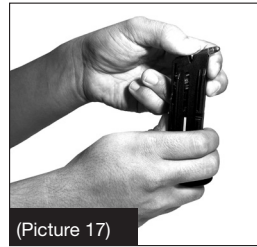
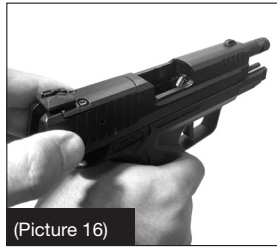

**WARNING** If you experience a weak report (weak gunshot sound) or light recoil upon firing, you may have fired a “squib” (underpowered) cartridge, which may have left a bullet lodged in the barrel. **STOP FIRING IMMEDIATELY.** Engage the safety lever by moving it to “Safe” (White Dot Showing). “Clear” (unload) the firearm, leaving the safety lever on “Safe,” the magazine removed, the firearm unloaded, and the cocking lever engaged in the recess in the cocking lever housing. Then field strip the firearm and look through the bore from the rear to be sure it is unobstructed. If the bore is unobstructed, you may reassemble and load the firearm and continue firing. If there is an obstruction in the bore, the firearm should be taken to a qualified gunsmith or certified armorer, or returned to the factory, for the obstruction to be removed and the barrel to be inspected for damage before continuing to use the firearm. *NEVER attempt to “shoot out” an obstruction by firing another cartridge, even a cartridge from which the bullet has been removed, in the firearm. Damage to the firearm, serious injury or death could result!*

**UNLOADING**

To unload the pistol, while keeping your finger off the trigger, press the magazine release button on the grip of the frame near your thumb (picture 13). The magazine should fall free from the grip, if it does not, simply hold the magazine release button and pull the magazine from its recess in the grip until fully removed (picture 14). Place the magazine inside the box (picture 19). Rack the slide to eject any remaining ammunition in the chamber (picture 15). Fully pull the slide back and visually inspect the chamber to ensure the firearm is cleared (picture 16). Close the slide and place the firearm on safe, install a chamber flag if necessary (picture 17). Place the RXP-22 back into the case (picture 20). Unload any remaining ammunition from the magazine if necessary (picture 17).

**DISASSEMBLY- ASSEMBLY**

(Picture 22)



(Picture 23)



(Picture 24)



(Picture 25)



(Picture 26)

- Remove the magazine by pressing on the button and drop the slide by pressing the slide lock if locked open (Picture 22).
- Turn the takedown lever 90 degrees counterclockwise and pull it out of the frame (Picture 23).
- Pull the slide fully rearward (Picture 24), then tilt the rear upward and slide it forward over the end of the barrel to remove the slide from the frame. The firearm is now “field stripped”.
- Retay does not advise users to dismantle other parts to prevent the possibility of minor injuries due to the use of hand tools, losing parts and facing problems during re-assembly. (Picture 26)
- To reassemble your firearm follow the steps backwards in the same order.

## SIGHT ADJUSTMENT

### Windage Adjustment:

If the rear sight needs to be adjusted for windage, follow these procedures.

Loosen the tensioning set screw at the top of the rear sight.

If your shots are going LEFT, you must adjust the rear sight to the RIGHT

If your shots are going RIGHT, you must adjust the rear sight to the LEFT

## MAINTENANCE

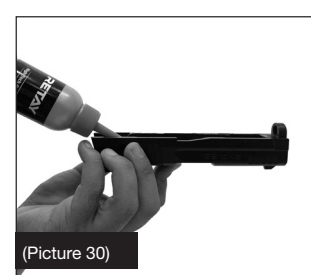
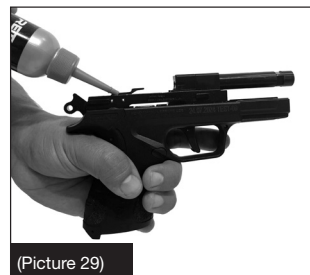

- Keep your firearm away from dusty, humid and acidic environments.
- After you are finished shooting, clean barrel and chamber with gun cleaner on a fine barrel brush (Picture 27)
- Next clean the moving parts like the slide and magazine. These parts should also be lubricated. (Picture 28-29-30).
- Do not keep the magazine loaded when the firearm is not in use.
- If the firearm does not cycle, the ammunition may not be powerful enough to fully cycle the action. The action may also be too dirty to function and may need cleaning after prolonged use. If the problem continues, contact Retay customer service for help.

## REPAIRS AND CUSTOMER SERVICE

RETAY USA CUSTOMER SERVICE: [www.retayusa.com](http://www.retayusa.com) 800-977-5749

RETAY TURKEY CUSTOMER SERVICE: [www.retayarms.com.tr](http://www.retayarms.com.tr) / [bilgi@retayarms.com](mailto:bilgi@retayarms.com) +90 332 342 6513

## LIMITED WARRANTY

Refer to the warranty card supplied with your firearm

## LIMITATION OF LIABILITY

Retay excludes and will not be responsible for any incidental or consequential damages with respect to economic loss or injury to person or property, whether as a result of express or implied warranty, negligence or otherwise. Some states do not allow the exclusion of limitation of incidental or consequential damages, so the above limitation may not apply to you. Retay will not be responsible for the results of careless handling, unauthorized adjustments, defective, low quality, reloaded, or improper ammunition, corrosion, neglect, ordinary wear and tear, or unreasonable use. Furthermore, the liability of Retay under this warranty shall be limited solely to the obligation to repair or replace the firearm. Retay's obligations under this warranty shall not apply to the extent that any law, regulation, or other governmental requirement prohibits the repair, replacement, and/or return of the firearm to the person who sent the firearm to Retay.

## YOUTH HANDGUN SAFETY ACT NOTICE

- (1) The misuse of handguns is a leading contributor to juvenile violence and fatalities.
- (2) Safely storing and securing firearms away from children will help prevent the unlawful possession of handguns by juveniles, stop accidents, and save lives.
- (3) Federal law prohibits, except in certain limited circumstances, anyone under 18 years of age from knowingly possessing a handgun, or any person from selling, delivering, or otherwise transferring a handgun to a person under 18.
- (4) A knowing violation of the prohibition against selling, delivering, or otherwise transferring a handgun to a person under the age of 18 is, under certain circumstances, punishable by up to 10 years in prison.

**FEDERAL LAW** The Gun Control Act of 1968, 18 U.S.C. Chapter 44, provides in pertinent part as follows:

18 U.S.C. 922(x)

- (x)(1) It shall be unlawful for a person to sell, deliver, or otherwise transfer to a person who the transferor knows or has reasonable cause to believe is a juvenile— (A) a handgun; or (B) ammunition that is suitable for use only in a handgun.
- (2) It shall be unlawful for any person who is a juvenile to knowingly possess— (A) a handgun; or (B) ammunition that is suitable for use only in a handgun.
- (3) This subsection does not apply to— (A) a temporary transfer of a handgun or ammunition to a juvenile or to the possession or use of a handgun or ammunition by a juvenile if the handgun and ammunition are possessed and used by the juvenile— (i) in the course of employment, in the course of ranching or farming related to activities at the residence of the juvenile (or on property used for ranching or farming at which the juvenile, with the permission of the property owner or lessee, is performing activities related to the operation of the farm or ranch), target practice, hunting, or a course of instruction in the safe and lawful use of a handgun; (ii) with the prior written consent of the juvenile's parent or guardian who is not prohibited by Federal, State, or local law from possessing a firearm, except— (I) during transportation by the juvenile of an unloaded handgun in a locked container directly from the place of transfer to a place at which an activity described in clause (i) is to take place and transportation by the juvenile of that handgun, unloaded and in a locked container directly from the place at which such an activity took place to the transferor; or (II) with respect to ranching or farming activities as described in clause (i), a juvenile may possess and use a handgun or ammunition with the prior written approval of the juvenile's parent or legal guardian and at the direction of an adult who is not prohibited by Federal, State or local law from possessing a firearm; (iii) the juvenile has the prior written consent in the juvenile's possession at all times when a handgun is in the possession of the juvenile; and (iv) in accordance with State and local law; (B) a juvenile who is a member of the Armed Forces of the United States or the National Guard who possesses or is armed with a handgun in the line of duty; (C) a transfer by inheritance of title (but not possession) of a handgun or ammunition to a juvenile; or (D) the possession of a handgun or ammunition by a juvenile taken in defense of the juvenile or other persons against an intruder into the residence of the juvenile or a residence in which the juvenile is an invited guest.

(4) A handgun or ammunition, the possession of which is transferred to a juvenile in circumstances in which the transferor is not in violation of this subsection shall not be subject to permanent confiscation by the Government if its possession by the juvenile subsequently becomes unlawful because of the conduct of the juvenile, but shall be returned to the lawful owner when such handgun or ammunition is no longer required by the Government for the purposes of investigation or prosecution.

(5) For purposes of this subsection, the term “juvenile” means a person who is less than 18 years of age.

(6)(A) In a prosecution of a violation of this subsection, the court shall require the presence of a juvenile defendant’s parent or legal guardian at all proceedings. (B) The court may use the contempt power to enforce subparagraph (A). (C) The court may excuse attendance of a parent or legal guardian of a juvenile defendant at a proceeding in a prosecution of a violation of this subsection for good cause shown.

#### **18 U.S.C. 924(a)(6)**

(6)(A)(i) A juvenile who violates section 922(x) shall be fined under this title, imprisoned not more than 1 year, or both, except that a juvenile described in clause (ii) shall be sentenced to probation on appropriate conditions and shall not be incarcerated unless the juvenile fails to comply with a condition of probation. (ii) A juvenile is described in this clause if— (I) the offense of which the juvenile is charged is possession of a handgun or ammunition in violation of section 922(x)(2); and (II) the juvenile has not been convicted in any court of an offense (including an offense under section 922(x) or a similar State law, but not including any other offense consisting of conduct that if engaged in by an adult would not constitute an offense) or adjudicated as a juvenile delinquent for conduct that if engaged in by an adult would constitute an offense. (B) A person other than a juvenile who knowingly violates section 922(x)— (i) shall be fined under this title, imprisoned not more than 1 year, or both; and (ii) if the person sold, delivered, or otherwise transferred a handgun or ammunition to a juvenile knowing or having reasonable cause to know that the juvenile intended to carry or otherwise possess or discharge or otherwise use the handgun or ammunition in the commission of a crime of violence, shall be fined under this title, imprisoned not more than 10 years, or both.



**WARNING:** Cancer and Reproductive Harm - [www.P65Warnings.ca.gov](http://www.P65Warnings.ca.gov).

## **STATE-MANDATED WARNINGS**

As Retay sells firearms in multiple states, the warnings mandated by the laws of various states are included herein.

California



**Warning:** Firearms must be handled responsibly and securely stored to prevent access by children and other unauthorized users. California has strict laws pertaining to firearms, and you may be fined or imprisoned if you fail to comply with them. Visit the website of the California Attorney General at <https://oag.ca.gov/firearms> for information on firearm laws applicable to you and how you can comply. Prevent child access by always keeping guns locked away and unloaded when not in use. If you keep a loaded firearm where a child obtains and improperly uses it, you may be fined or sent to prison. If you or someone you know is contemplating suicide, please call the national suicide prevention lifeline at 1-800-273-TALK (8255).



**Advertencia:** Las armas de fuego deben ser manejadas de manera responsable y segura para evitar el acceso de los niños y otros usuarios no autorizados. California tiene leyes estrictas relativas a las armas de fuego, y usted puede ser multado o encarcelado si no las cumple. Visite el sitio web del Fiscal General de California en <https://oag.ca.gov/firearms> para obtener información sobre las leyes sobre armas de fuego que le son aplicables y cómo puede cumplir. Evitar el acceso de los niños manteniendo siempre las armas cerradas y descargadas cuando no estén en uso. Si usted guarda un arma de fuego cargada donde un niño lo obtiene y lo usa indebidamente, puede ser multado o enviado a prisión. Si usted o alguien que usted conoce está pensando en suicidarse, por favor llame a la línea nacional de prevención del suicidio al 1-800-273-TALK (8255).

### Connecticut

UNLAWFUL STORAGE OF A LOADED FIREARM MAY RESULT IN IMPRISONMENT OR FINE.

### Florida

It is unlawful, and punishable by imprisonment and fine, for any adult to store or leave a firearm in any place within the reach or easy access of a minor under 18 years of age or to knowingly sell or otherwise transfer ownership or possession of a firearm to a minor or a person of unsound mind.

### Massachusetts

It is unlawful to store or keep a firearm, rifle, shotgun or machine gun in any place unless that weapon is equipped with a tamper-resistant safety device or is stored or kept in a securely locked container.

### New Jersey

It is a criminal offense, punishable by a fine and imprisonment, for an adult to leave a loaded firearm within easy access of a minor.

### New York City

Warning: Responsible firearm storage is the law in New York State, as defined by the NY Safe Act. Firearms must be stored in a safe or other secure container which, when locked, is incapable of being opened without the key, combination or other unlocking mechanism and is capable of preventing an unauthorized person from obtaining access to and possession of the device appropriate to that firearm. Leaving firearms accessible to a child or unauthorized person may subject you to imprisonment, fine, or both. You may also face additional criminal penalties if the firearm is used by another negligently and civil liability.

### North Carolina

Section 14-315.1 Storage of firearms to protect minors. (a) Any person who resides in the same premises as a minor, owns or possesses a firearm, and stores or leaves the firearm (i) in a condition that the firearm can be discharged and (ii) in a manner that the person knew or should have known that an unsupervised minor would be able to gain access to the firearm, is guilty of a Class 1 misdemeanor if a minor gains access to the firearm without the lawful permission of the minor's parents or a person having charge of the minor and the minor: (1) Possesses it in violation of G.S. 14-269.2(b); (2) Exhibits it in a public place in a careless, angry, or threatening manner; (3) Causes personal injury or death with it not in self defense; or (4) Uses it in the commission of a crime. (b) Nothing in this section shall prohibit a person from carrying a firearm on his or her body, or placed in such close proximity that it can be used as easily and quickly as if carried on the body. (c) This section shall not apply if the minor obtained the firearm as a result of an unlawful entry by any person. (d) "Minor" as used in this section means a person under 18 years of age who is not emancipated.

### Washington

Warning: You may face criminal prosecution if you store or leave an unsecured firearm where a person who is prohibited from possessing firearms can and does obtain possession.

### Wisconsin

If you leave a loaded firearm within the reach or easy access of a child you may be fined or imprisoned or both if the child improperly discharges, possesses or exhibits the firearm.

<b>RETAY RXP22 Cal .22LR TECHNICAL SPECIFICATIONS</b>	
MAGAZINE CAPACITY	10+1/13+1 Cartridges
OVERALL LENGTH	180 mm / 7"
HEIGHT	130.5 mm / 5"
WIDTH	29 mm / 1.2"
BARREL LENGTH	90 mm / 3.5"
UNLOADED WEIGHT	850 g / 1.8lbs
CALIBER	.22LR
LOADED MAGAZINE WEIGHT	128 g/133 g / 0.28lbs/0.3lbs
NUMBER OF PARTS	37 PCS

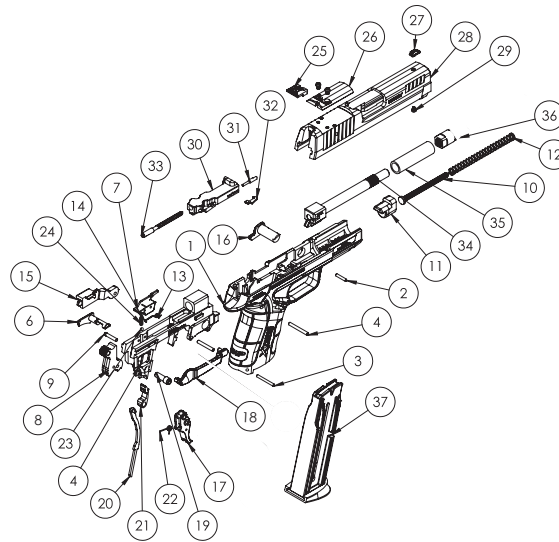

No	Name	Pcs	13	Slide Release Spring Pin	1	26	Slide Guide	1
1	Frame	1	14	Slide Release Spring	1	27	Front Sight	1
2	Ø2,5x14 Spiral pin	1	15	Slide Release	1	28	Slide	1
3	Ø2,5x24 Spiral pin	1	16	Slide Release Catch	1	29	Front Sight Screw	1
4	Ø3x26 Spiral pin	1	17	Trigger	1	30	Mechanism with Surface Treatment	1
5	Inner frame	1	18	Trigger Grip	1	31	Extractor pin	1
6	Slide catch	1	19	Sear Pin	1	32	Extractor	1
7	Ejector	1	20	Hammer Rear Frame Pin	1	33	Firing Pin	1
8	Hammer	1	21	Sear	1	34	Barrel	1
9	Hammer Connection Pin	1	22	Sear Trip Spring	1	35	Barrel Nut	1
10	Recoil Spring Guide	1	23	Housing Fire Control	1	36	Barrel Collar Threaded	1
11	Slide Buffer	1	24	Safety Catch Spring	1	37	Magazine	1
12	Shaft Spring	1	25	Rear Sight	1			







# RETAY

Retay Arms Ltd. Sti.

Büyükkayacık Mh. 4. OSB, 103. Cd., No: 11, 42250 Konya/TURKEY

Pbx: +90 332 342 6513 | Fax: +90 332 342 6514 | E-mail: info@retayarms.com

www.retayarms.com - www.retayusa.com

Retay Arms reserves the right to make modifications to the products shown in this catalogue at any time without prior notice. The finishings, colour and patterns shown in this catalogue are approximate, as a printed reproduction causes inevitable colour differences. The illustrations and descriptions contained in this catalogue are only provided as an indication.

